

Installation and operating instructions for R+W metal bellow couplings Models BK-BKL-MK



Please read the following installation, operation and maintenance procedures for the R+W metal bellow couplings completely. Failure to comply with these procedures may result in the failure of the coupling.

Installation of the couplings should be performed by a qualified technician.

General function



R+W metal bellow couplings are flexible shaft couplings.

They are backlash free, torsionally rigid and transmit torque and precise angular motion by means of a thin-walled stainless steel metal bellow connected to different hub designs. The metal bellow compensates for angular, axial and lateral shaft misalignments simultaneously with low restoring forces.

Standard shaft / Hub designs

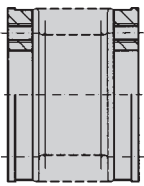

attached flange

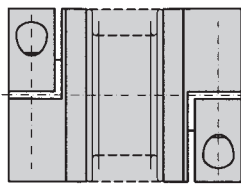

clamping hub

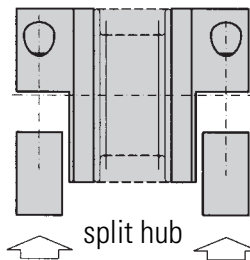

split hub

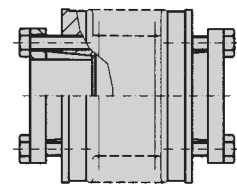

tapered bushings

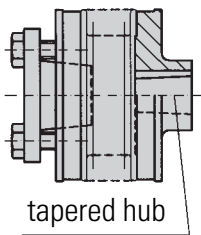

tapered hub

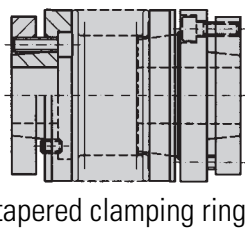

tapered clamping rings

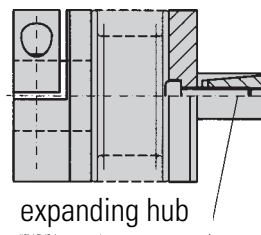

expanding hub

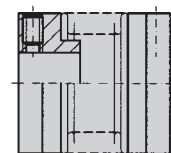

radial set screw



R+W metal bellow couplings may only be used in accordance with the technical data supplied in the catalog.

Transport

R+W metal bellow couplings are delivered ready for installation. After incoming inspection the coupling should be stored in its original packaging until it is ready for installation. A copy of this installation, operation, an maintenance manual should be kept with the coupling.

Safety alert



Rotating couplings can be very dangerous. Proper guarding should be in place at all times and is the responsibility of the machine builder, user or operator. Do not approach or touch a coupling while it is rotating. Make sure that the machine is "locked out" and cannot be accidentally started during installation or maintenance of the coupling.

Manufacturer's declaration

According to EG guidelines for machinery 89/392 EWG Appendix 11B

In the sense of machine guidelines (MR) shaft couplings are no machines, but components for the installation in machines. Their putting into operation is subject to the fulfillment of all requirements of machine guidelines by or after integration in the final product.

Mounting preparation

When mounting or dismounting, the metal bellow may only be deformed 1.5 times the maximum permissible misalignment values indicated in the catalog. Avoid any excessive force while mounting the coupling! All mounting surfaces including shafts, keys, bores and key ways, must be clean and free of burrs, nicks and dents. Inspect shaft diameters, coupling bore diameters, key and key-way dimensions and tolerances. All R+W coupling bores are machined to ISO tolerance H7. The expanding mandrels of the MK3 are machined to ISO tolerance f7 and BK7 hub shafts are machined to ISO tolerance h7. Clearances between shaft and hub are maintained to 0.01 and 0.05 mm. A light coating of oil is recommended to ease the mounting process and will not affect the clamping force of the hub.



CAUTION: Do not use sliding grease, or oils or grease with molybdenum disulfide or other high pressure additives.

R+W
COUPLING TECHNOLOGY

Attached flange connection: Model BK 1

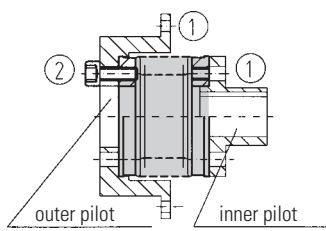

Figure 9

Mounting:

The BK1 can be piloted with either the ID or OD of the coupling hub. Mount the coupling to the customer supplied flange and fasten with mounting screws 2. Tighten the fastening screws to the correct tightening torque, supplied by the customer, with a torque wrench.

Dismounting:

Simply loosen the flange mounting screws and remove the coupling.

Clamping hub connection: Model BK 2 / BKL / MK 2

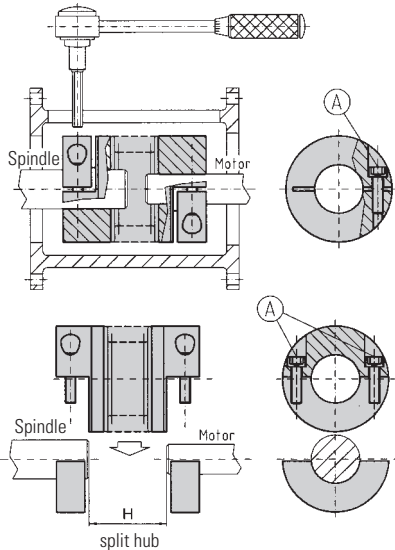

Figure 10

Mounting:

Prior to mounting make sure that the shafts to be connected do not exceed the angular or lateral misalignment limits for the coupling to be used. This data can be found in the catalog. Slide the metal bellow coupling onto the motor shaft end. When the correct axial position has been reached tighten the clamp screw (A) to the correct tightening torque as indicated in table 1 with a torque wrench. Insert the spindle shaft into the other end of the coupling to the proper axial position. Make sure that the coupling is free of any axial forces before tightening. Tighten the clamp screw (A) as above using a torque wrench to the proper tightening torque. For the split hub design it is necessary to maintain the proper separation between shaft ends (dimension H in the catalog).



CAUTION: For the split hub design the shafts must extend into the coupling to the full width of the split hub clamps.

Dismounting:

Simply loosen the clamp screws and remove the coupling.

Tapered hub connection: Model BK 3

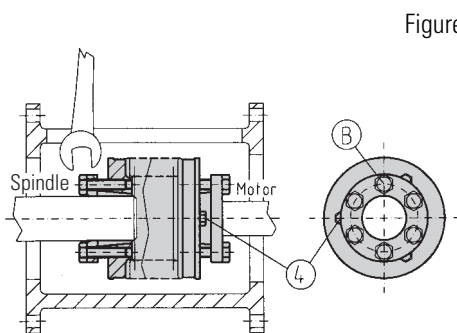

Figure 11

Mounting:

Prior to mounting make sure that the shaft to be connected do not exceed the angular or lateral misalignment limits for the coupling to be used. This data can be found in the catalog. Slide the coupling onto the motor shaft to the proper axial position. Using a torque wrench, uniformly tighten the clamping screws (B) using a cross-wise tighten pattern until all the clamping screws are evenly tightened to the correct tightening torque as given in table 1.



CAUTION: Further tightening of the clamping screws (B) may destroy the tapered bushing connection.

Dismounting:

Loosen the clamping screws (B). Use the three jack screws (4) to "back out" the tapered section.



CAUTION: Prior to re-assembly make sure the three jack screws (4) are raised to their original position.

Clamping hub connection: Model BK 4

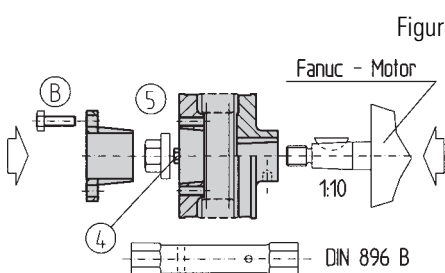

Figure 12

Mounting:

Prior to mounting make sure that the shafts to be connected do not exceed the angular or lateral misalignment limits for the coupling to be used. This data can be found in the catalog. Slide the metal bellow coupling onto the motor shaft end. When the correct axial position has been reached tighten the nut (5) to the correct tightening torque as specified by the customer with a torque wrench. Insert the second shaft into the other end of the coupling to the proper axial position. Using a torque wrench, uniformly tighten the clamping screws (B) using a cross-wise tighten pattern until all the clamping screws are evenly tightened to the correct tightening torque as given in table 1.

Dismounting: Loosen the clamping screws (B). Use the three jack screws (4) to "back out" the tapered section. Loosen assembly screw (5) and remove the coupling.



CAUTION: Prior to re-assembly make sure the three jack screws (4) are raised to their original position.

Tapered clamping ring connection: Model BK 6

Figure 13

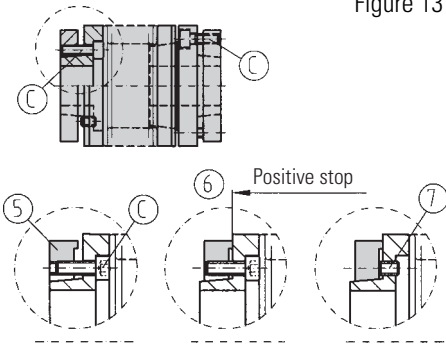

Mounting:

The BK 6 uses a clamping ring with axial fastening screws. Slide the male coupling hub onto the motor shaft, using a torque wrench, uniformly tighten the clamping screws C using a cross-wise tightening pattern until all the clamping screws are evenly tightened to the correct tightening torque as given in table 1. The clamping ring (5) will come to a positive stop (position 6).

Dismounting: Loosen the motor mounting screws. Remove the motor together with the male coupling segment. Loosen the clamping screws C. Use the three jack screws (7) to "back off" the clamping ring and remove the coupling.



CAUTION: Prior to re-assembly make sure the three jack screws (7) are raised to their original position.

Expanding hub connection: Models BK 7 / MK 3

Figure 14

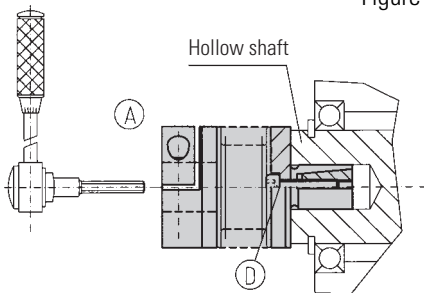

Mounting:

Completely insert the expanding shaft side of the coupling into the hollow bore. Using a torque wrench tighten clamping screw (D) to the proper tighten torque as indicated in table 1. Next insert the shaft end or encoder shaft into the other side of the coupling. Ensure that the shaft has been inserted to the proper axial position and that no residual axial forces remain on the coupling. Using a torque wrench tighten clamping screw (A) to the proper tighten torque as indicated in table 1.

Dismounting: Simply loosen the clamping screws (A) and (D) and remove the coupling. It may be necessary to apply axial pressure to the clamping screw (D) to remove expanding shaft.

Clamping set screw connection: Models MK 1 / MK 4

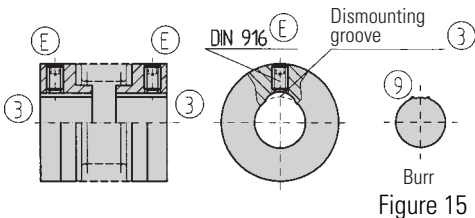

Figure 15

Mounting:

Slide the complete coupling onto the shaft end to the proper axial position. Using a torque wrench, tighten the set screws (E) to the proper tightening torque as indicated in table 1. Insert the second shaft end to the proper axial position and ensure no residual axial forces exist on the coupling. Tighten the set screws using the same procedure as on the first side. For series 10 couplings each hub has one set screw, series 15 and larger have two set screws per hub off set by 120 degree.

Dismounting:

Simply loosen the set screws (E) and remove the coupling. R+W couplings incorporate a unique dismounting groove that provides clearance for the set screw "burr" (9).

A shaft groove or flat are not longer necessary

Press-fit connections

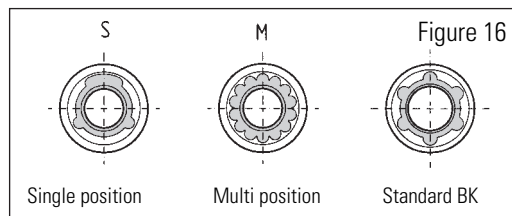
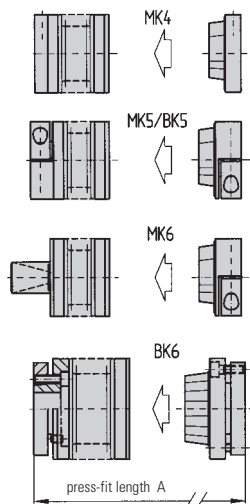

Mounting:

A shaft groove or flat are no longer necessary. Prior to mounting it is necessary to consider the overall length of the assembled coupling. The press fit coupling requires a specific pre-tensioning (F) between the two coupling halves to ensure backlash free operation. Mount the "female" coupling half containing the bellow onto the spindle shaft to the proper axial position. Tighten the clamping screw(s) per the mounting instructions for the coupling hub design. Mount the "male" coupling segment onto the motor shaft. The proper axial position of the coupling segment on the motor shaft is when the motor is mounted the coupling is compressed by the proper pre-tension distance (F). When the coupling segment is properly positioned tighten the clamping screw to the proper tightening torque using a torque wrench. The coupling maximum misalignment values will not be affected by the pre-tensioning.

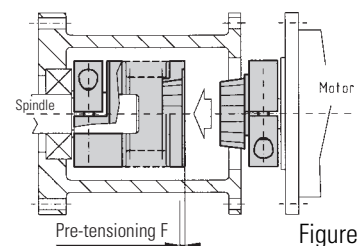

Figure 17

